

NAIS

HIGH INSULATION RELAYS (Conforming to the supplementary insulation class of EN Standards (EN41003))

TX-D RELAYS

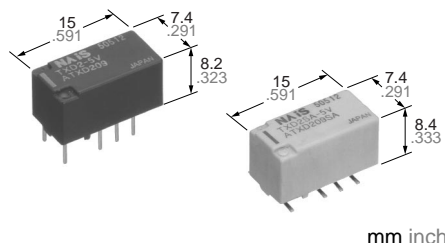

mm inch

FEATURES

- Approved to the supplementary insulation class in the EN standards (EN41003).

The insulation distance between the contact and coil meet the supplementary insulation class of the EN41003 standards as required for equipment connected to the telephone lines in Europe.

Satisfies the following conditions:

- Clearances: 2.0 mm .079 inch or more
- Creepage distance: 2.5 mm .098 inch or more

- **2,000 V breakdown voltage between contact and coil.**

The body block construction of the coil that is molded by plastic offers a high breakdown voltage of 2,000 V between contact and coil, and 1,000 V between open contacts.

- **Outstanding surge resistance.**

Surge withstand between open contacts: 1,500 V 10×160 μsec. (FCC part 68)

Surge withstand between contact and coil: 2,500 V 2×10 μsec. (Bellcore)

- **High sensitivity 200 mW.**

- **High contact capacity: 2 A 30 V DC (Standard type)**

- **Surface-mount type also available.**

- **M.B.B. type also available**

- **The use of gold-clad twin crossbar contacts ensures high contact reliability.**

- **Outstanding vibration and shock resistance.**

Functional shock resistance:

750 m/s² {75G}

Destructive shock resistance:

1,000 m/s² {100G}

Functional vibration resistance:

10 to 55 Hz (at double amplitude of 3.3 mm .130 inch)

Destructive vibration resistance:

10 to 55 Hz (at double amplitude of 5 mm .197 inch)

- **Sealed construction allows automatic washing.**

SPECIFICATIONS

Contact

		Standard (B.B.M) type	M.B.B.type
Arrangement		2 Form C	2 Form D
Initial contact resistance, max. (By voltage drop 6 V DC 1 A)		100 mΩ	
Contact material		Gold-clad silver	
Rating	Nominal switching capacity (resistive load)	2 A 30 V DC	1 A 30 V DC
	Max. switching power (resistive load)	60 W	30 W
	Max. switching voltage	220 V DC	110 V DC
	Max. switching current	2 A	1 A
	Min. switching capacity ※1	10 μA 10 mV DC	
	Nominal operating power	Single side stable	200 mW (1.5 to 12 V DC) 230 mW (24 V DC)
1 coil latching		150 mW (1.5 to 12 V DC) 170 mW (24 V DC)	—
Expected life (min. operations)	Mechanical (at 180 cpm)	10 ⁸	10 ⁷
	Electrical (at 20 cpm)	10 ⁵ (2 A 30 V DC resistive), 5 × 10 ⁵ (1 A 30 V DC resistive)	10 ⁵ (1 A 30 V DC resistive)

Notes:

※1 This value can change due to the switching frequency, environmental conditions, and desired reliability level, therefore it is recommended to check this with the actual load.

※2 The upper limit for the ambient temperature is the maximum temperature that can satisfy the coil temperature rise. Under the packing condition, allowable temperature range is from -40 to +70°C -40°C to +158°F.

Remarks

- * Specifications will vary with foreign standards certification ratings.
- *1 Measurement at same location as "Initial breakdown voltage" section.
- *2 Detection current: 10 mA
- *3 By resistive method; nominal voltage applied to the coil; contact carrying current: 2 A.
- *4 By resistive method; nominal voltage applied to the coil; contact carrying current: 1 A.
- *5 Nominal voltage applied to the coil, excluding contact bounce time.
- *6 Nominal voltage applied to the coil, excluding contact bounce time without diode.
- *7 Half-wave pulse of sine wave: 6 ms.; detection time: 10 μs.
- *8 Half-wave pulse of sine wave: 11 ms.; detection time: 10 μs.
- *9 Half-wave pulse of sine wave: 6 ms.
- *10 Detection time: 10 μs.
- *11 Refer to 4. Conditions for operation, transport and storage mentioned in Cautions for use (Page 178).

Characteristics

		Standard (B.B.M) type	M.B.B.type
Initial insulation resistance*1		Min. 1,000 MΩ (at 500 V DC)	
Initial break-down voltage*2	Between open contacts	1,000 Vrms for 1 min.	500 Vrms for 1 min.
	Between contact and coil	2,000 Vrms for 1 min.	
Initial surge voltage	Between contact sets	1,000 Vrms for 1 min.	
	Between contacts, 10 × 160 μs	1,500 V [FCC Part 68]	—
Temperature rise (at 20°C)	Between contact and coil, 2 × 10 μs	2,500 V [Bellcore]	
		Max. 50°C*3	Max. 50°C*4
Operate time [Set time]*5 (at 20°C)		Max. 4 ms (Approx. 2 ms) [Max. 4 ms (Approx. 2 ms)]	Max. 4 ms (Approx. 2 ms)
		Max. 4 ms (Approx. 1 ms) [Max. 4 ms (Approx. 2 ms)]	Max. 4 ms (Approx. 1 ms)
M.B.B. time*12		—	Min. 10 μs
		Min. 750 m/s ² {75 G}*7	Min. 500 m/s ² {50 G}*8
Shock resistance	Functional	Min. 1,000 m/s ² {100 G}	
	Destructive*9		
Vibration resistance	Functional*10	10 to 55 Hz at double amplitude of 3.3 mm	
	Destructive	10 to 55 Hz at double amplitude of 5 mm	
Conditions for operation, transport and storage*11 (Not freezing and condensing at low temperature)	Ambient temp. ※2	-40°C to +85°C -40°F to +185°F	
	Humidity	5 to 85%R.H.	
Unit weight		Approx. 2 g .071 oz.	

*12 M.B.B. time:

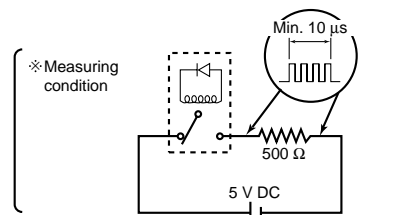

TYPICAL APPLICATIONS

- Facsimiles
- Modems
- Communication devices

ORDERING INFORMATION

1) Standard (B.B.M.) type

Ex. TXD 2 SA - L - - 4.5V - Z

Contact arrangement	Surface-mount availability	Operating function	Terminal shape	Coil voltage (DC)	Packing style
2: 2 Form C	Nil: Standard PC board terminal or self-clinching terminal SA: Standard surface-mount terminal SL: High connection reliability surface-mount terminal type SS: Space saving surface-mount terminal type	Nil: Single side stable L: 1 coil latching	Nil: Standard PC board terminal or surface-mount type H: Self-clinching terminal	1.5, 3, 4.5, 5, 6, 9, 12, 24 V	Nil: Tube packing Z: Tape and reel packing (Picked from the 8/9/10/12-pin side)

2) M.B.B. type

Ex. TXD 2 SA - 2M - - 4.5V - Z

Contact arrangement	Surface-mount availability	Operating function	Terminal shape	Coil voltage (DC)	Packing style
2: 2 Form D	Nil: Standard PC board terminal or self-clinching terminal SA: Standard surface-mount terminal SL: High connection reliability surface-mount terminal type SS: Space saving surface-mount terminal type	2M: 2 M.B.B. type	Nil: Standard PC board terminal or surface-mount type H: Self-clinching terminal	1.5, 3, 4.5, 5, 6, 9, 12, 24 V	Nil: Tube packing Z: Tape and reel packing (Picked from the 8/9/10/12-pin side)

Notes: 1. Tape and reel (picked from 1/3/4/5-pin side) is also available by request. Part number. suffix "-X" is needed when ordering.
(ex.) TXD2SA-3V-X
2. Tape and reel packing symbol "-Z" or "-X" are not marked on the relay.

Surface-mount terminal variation

Variation	Terminal style	Usable conditions based on terminal connection solder reliability	
		Normal environments (indoor)	Drastic temperature fluctuations (outdoor)
SA type (Standard surface-mount terminal type)		Recommended	—
SL type (Highly connection reliability surface-mount terminal type)		Recommended	Recommended
SS type (Space saving surface-mount terminal type)		Recommended	Recommended

OPERATION INFORMATION

Contact Operation	Open	During Operation	Operation Complete	During Reset	Reset Complete
M.B.B. contact operation					
Standard (B.B.M.) contact operation					

TX-D

TYPES AND COIL DATA (at 20°C 68°F)

1. Standard (B.B.M.) type

(1) Standard PC board terminal and self-clinching terminal

1. Single side stable

Coil Rating, V DC	Part No. V DC		Pick-up voltage, V DC (max.) (initial)	Drop-out voltage, V DC (min.) (initial)	Nominal operating current, mA (±10%)	Coil resistance, Ω (±10%)	Nominal operating power, mW	Max. allowable voltage, V DC
	Standard PC board terminal	Self-clinching terminal						
1.5	TXD2-1.5V	TXD2-H-1.5V	1.13	0.15	132.7	11	200	1.8
3	TXD2-3V	TXD2-H-3V	2.25	0.3	66.7	45	200	3.6
4.5	TXD2-4.5V	TXD2-H-4.5V	3.38	0.45	44.4	101	200	5.4
5	TXD2-5V	TXD2-H-5V	3.75	0.5	40.0	125	200	6
6	TXD2-6V	TXD2-H-6V	4.5	0.6	33.3	180	200	7.2
9	TXD2-9V	TXD2-H-9V	6.75	0.9	22.2	405	200	10.8
12	TXD2-12V	TXD2-H-12V	9	1.2	16.7	720	200	14.4
24	TXD2-24V	TXD2-H-24V	18	2.4	9.6	2,504	230	28.8

2. 1 coil latching

Coil Rating, V DC	Part No.		Set voltage, V DC (max.) (initial)	Reset voltage, V DC (max.) (initial)	Nominal operating current, mA (±10%)	Coil resistance, Ω (±10%)	Nominal operating power, mW	Max. allowable voltage, V DC
	Standard PC board terminal	Self-clinching terminal						
1.5	TXD2-L-1.5V	TXD2-L-H-1.5V	1.13	1.13	100.0	15	150	1.8
3	TXD2-L-3V	TXD2-L-H-3V	2.25	2.25	50.0	60	150	3.6
4.5	TXD2-L-4.5V	TXD2-L-H-4.5V	3.38	3.38	33.3	135	150	5.4
5	TXD2-L-5V	TXD2-L-H-5V	3.75	3.75	30.0	166	150	6
6	TXD2-L-6V	TXD2-L-H-6V	4.5	4.5	25.0	240	150	7.2
9	TXD2-L-9V	TXD2-L-H-9V	6.75	6.75	16.7	540	150	10.8
12	TXD2-L-12V	TXD2-L-H-12V	9	9	12.5	960	150	14.4
24	TXD2-L-24V	TXD2-L-H-24V	18	18	7.1	3,388	170	28.8

Standard packing: 40 pcs. in an inner package (tube); 1,000 pcs. in an outer package.
 Note: In case of 5 V transistor drive circuit, it is recommended to use 4.5 V type relay.

(2) Surface-mount terminal

1. Single side stable

Coil Rating, V DC	Part No.		Pick-up voltage, V DC (max.) (initial)	Drop-out voltage, V DC (min.) (initial)	Nominal operating current, mA (±10%)	Coil resistance, Ω (±10%)	Nominal operating power, mW	Max. allowable voltage, V DC
	Tube packing	Tape and reel packing						
1.5	TXD2S○-1.5V	TXD2S○-1.5V-Z	1.13	0.15	132.7	11	200	1.8
3	TXD2S○-3V	TXD2S○-3V-Z	2.25	0.3	66.7	45	200	3.6
4.5	TXD2S○-4.5V	TXD2S○-4.5V-Z	3.38	0.45	44.4	101	200	5.4
5	TXD2S○-5V	TXD2S○-5V-Z	3.75	0.5	40.0	125	200	6
6	TXD2S○-6V	TXD2S○-6V-Z	4.5	0.6	33.3	180	200	7.2
9	TXD2S○-9V	TXD2S○-9V-Z	6.75	0.9	22.2	405	200	10.8
12	TXD2S○-12V	TXD2S○-12V-Z	9	1.2	16.7	720	200	14.4
24	TXD2S○-24V	TXD2S○-24V-Z	18	2.4	9.6	2,504	230	28.8

2. 1 coil latching

Coil Rating, V DC	Part No.		Set voltage, V DC (max.) (initial)	Reset voltage, V DC (max.) (initial)	Nominal operating current, mA (±10%)	Coil resistance, Ω (±10%)	Nominal operating power, mW	Max. allowable voltage, V DC
	Tube packing	Tape and reel packing						
1.5	TXD2S○-L-1.5V	TXD2S○-L-1.5V-Z	1.13	1.13	100.0	15	150	1.8
3	TXD2S○-L-3V	TXD2S○-L-3V-Z	2.25	2.25	50.0	60	150	3.6
4.5	TXD2S○-L-4.5V	TXD2S○-L-4.5V-Z	3.38	3.38	33.3	135	150	5.4
5	TXD2S○-L-5V	TXD2S○-L-5V-Z	3.75	3.75	30.0	166	150	6
6	TXD2S○-L-6V	TXD2S○-L-6V-Z	4.5	4.5	25.0	240	150	7.2
9	TXD2S○-L-9V	TXD2S○-L-9V-Z	6.75	6.75	16.7	540	150	10.8
12	TXD2S○-L-12V	TXD2S○-L-12V-Z	9	9	12.5	960	150	14.4
24	TXD2S○-L-24V	TXD2S○-L-24V-Z	18	18	7.1	3,388	170	28.8

○: For each surface-mounted terminal variation, input the following letter.

SA type: A, SL type: L, SS type: S

Standard packing: 40 pcs. (tube), 500 pcs. (tape and reel) in an inner package; 1,000 pcs. in an outer package

- Notes:**
1. Tape and reel packing symbol "-Z" is not marked on the relay. "X" type tape and reel packing (picked from 1/3/4/5-pin side) is also available.
 2. In case of 5 V transistor drive circuit, it is recommended to use 4.5 V type relay.

2. M.B.B. Type

(1) Standard PC board terminal and self-clinching terminal

Single side stable

Coil Rating, V DC	Part No.		Pick-up voltage, V DC (max.)	Drop-out voltage, V DC (min.)	Nominal operating current, mA (±10%)	Coil resistance, Ω (±10%)	Nominal operating power, mW	Max. allowable voltage, V DC
	Standard PC board terminal	Self-clinching terminal						
1.5	TXD2-2M-1.5V	TXD2-2M-H-1.5V	1.13	0.15	166.7	9	250	1.8
3	TXD2-2M-3V	TXD2-2M-H-3V	2.25	0.3	83.3	36	250	3.6
4.5	TXD2-2M-4.5V	TXD2-2M-H-4.5V	3.38	0.45	55.6	81	250	5.4
5	TXD2-2M-5V	TXD2-2M-H-5V	3.75	0.5	50.0	100	250	6
6	TXD2-2M-6V	TXD2-2M-H-6V	4.5	0.6	41.7	144	250	7.2
9	TXD2-2M-9V	TXD2-2M-H-9V	6.75	0.9	27.8	324	250	10.8
12	TXD2-2M-12V	TXD2-2M-H-12V	9	1.2	20.8	576	250	14.4
24	TXD2-2M-24V	TXD2-2M-H-24V	18	2.4	11.3	2,133	270	28.8

Standard packing: 40 pcs. in an inner package (tube); 1,000 pcs. in an outer package

(2) Surface-mount terminal

Single side stable

Coil Rating, V DC	Part No.		Set voltage, V DC (max.)	Reset voltage, V DC (min.)	Nominal operating current, mA (±10%)	Coil resistance, Ω (±10%)	Nominal operating power, mW	Max. allowable voltage, V DC
	Tube packing	Tape and reel packing						
1.5	TXD2S○-2M-1.5V	TXD2S○-2M-1.5V-Z	1.13	0.15	166.7	9	250	1.8
3	TXD2S○-2M-3V	TXD2S○-2M-3V-Z	2.25	0.3	83.3	36	250	3.6
4.5	TXD2S○-2M-4.5V	TXD2S○-2M-4.5V-Z	3.38	0.45	55.6	81	250	5.4
5	TXD2S○-2M-5V	TXD2S○-2M-5V-Z	3.75	0.5	50.0	100	250	6
6	TXD2S○-2M-6	TXD2S○-2M-6V-Z	4.5	0.6	41.7	144	250	7.2
9	TXD2S○-2M-9	TXD2S○-2M-9V-Z	6.75	0.9	27.8	324	250	10.8
12	TXD2S○-2M-12	TXD2S○-2M-12V-Z	9	1.2	20.8	576	250	14.4
24	TXD2S○-2M-24	TXD2S○-2M-24V-Z	18	2.4	11.3	2,133	270	28.8

○: For each surface-mounted terminal variation, input the following letter.

SA type: A, SL type: L, SS type: S

Standard packing: 40 pcs. (tube), 500 pcs. (tape and reel) in an inner package; 1,000 pcs. in an outer package

Notes:

1. Tape and reel packing symbol "-Z" is not marked on the relay. "X" type tape and reel packing (picked from 1/3/4/5-pin side) is also available.
2. In case of 5 V transistor drive circuit, it is recommended to use 4.5 V type relay.

DIMENSIONS

mm inch

1. Standard PC board terminal and self-clinching terminal

Standard PC board terminal

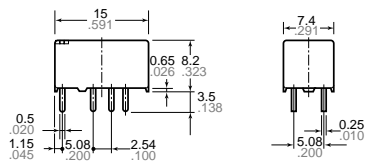

PC board pattern (Copper side view)

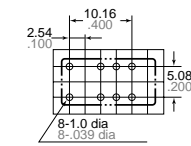

Tolerance: ±0.1 ±.004

Schematic (Bottom view)
Single side stable (Deenergized condition) 1 coil latching (Reset condition)

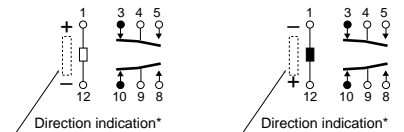

*Orientation stride located on top of relay.

Self clinching terminal

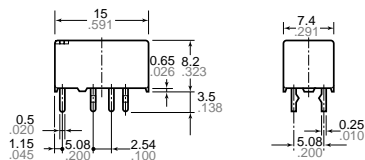

General tolerance: ±0.3 ±.012

TX-D

2. Surface-mount terminal

SA type

mm inch

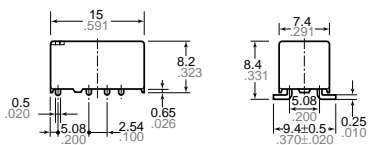

Suggested mounting pad (Top view)

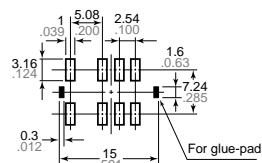

Schematic (Top view)
 Single side stable (Deenergized condition) 1 coil latching (Reset condition)

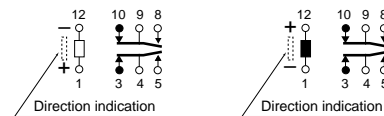

SL type

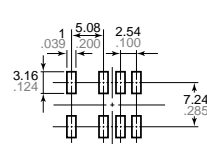
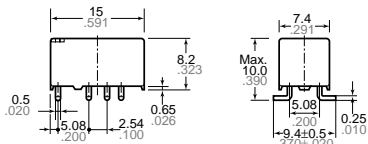

SS type

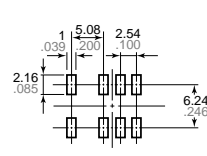
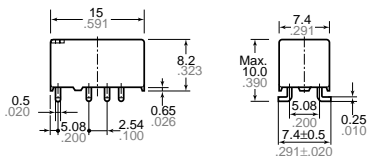

General tolerance: $\pm 0.3 \pm 0.12$

Tolerance: $\pm 0.1 \pm 0.04$

REFERENCE DATA

1. Maximum switching capacity

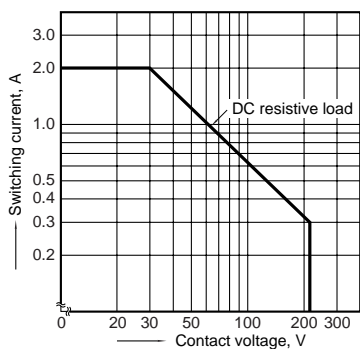

2. Life curve

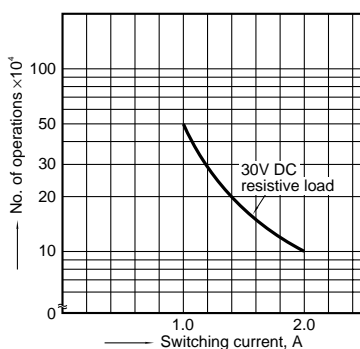

3. Mechanical life

Tested sample: TXD2-5V, 10 pcs.
 Operating frequency: 180 cpm

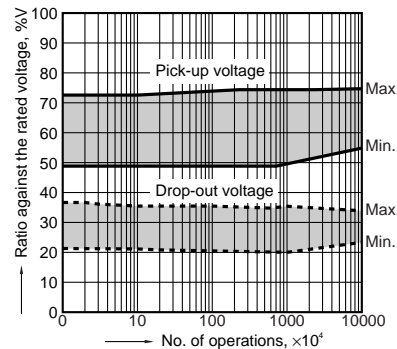

4. Electrical life (2 A 30 V DC resistive load)

Tested sample: TXD2-5V, 6 pcs.
 Operating frequency: 20 cpm
 Change of pick-up and drop-out voltage

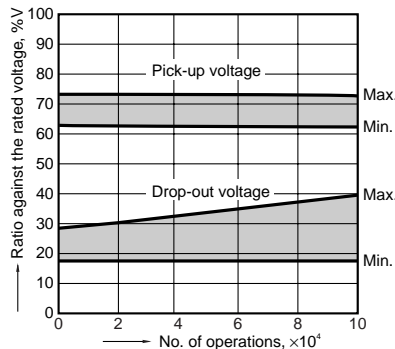

Change of contact resistance

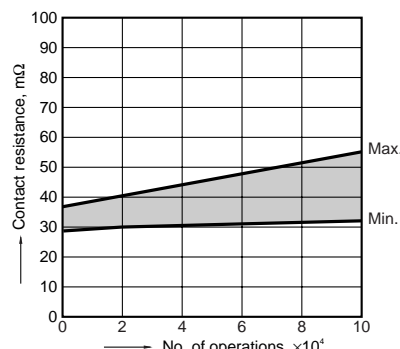

5-(1). Coil temperature rise

Tested sample: TXD2-5V, 6 pcs.
 Measured portion: Inside the coil
 Ambient temperature: 25°C 77°F, 70°C 158°F

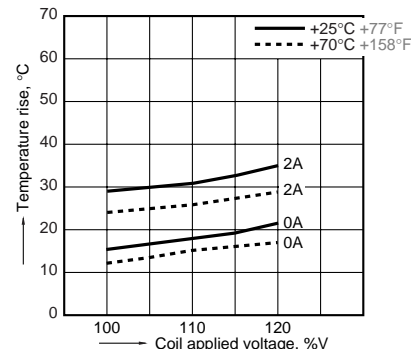

5-(2). Coil temperature rise

Tested sample: TXD2-24V, 6 pcs.

Measured portion: Inside the coil

Ambient temperature: 25°C 77°F, 70°C 158°F

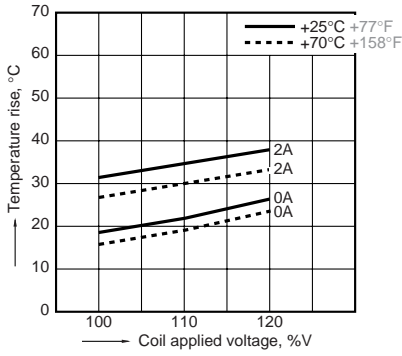

6-(1). Operate/release time characteristics (with diode)

Tested sample: TXD2-5V, 10 pcs.

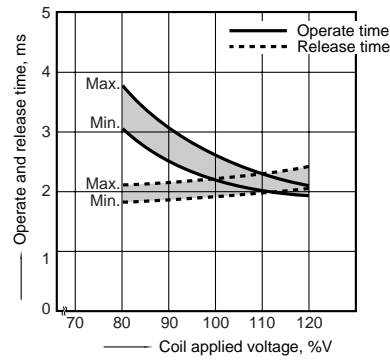

6-(2). Operate/release time characteristics (without diode)

Tested sample: TXD2-5V, 10 pcs.

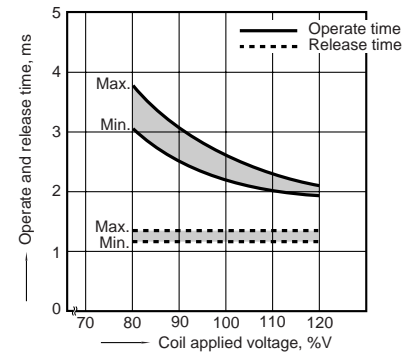

7. Distribution of pick-up and drop-out voltage

Tested sample: TXD2-5V, 50 pcs.

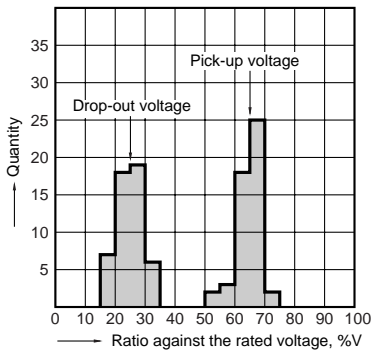

8. Distribution of set and reset voltage

Tested sample: TXD2-L-12V, 30 pcs.

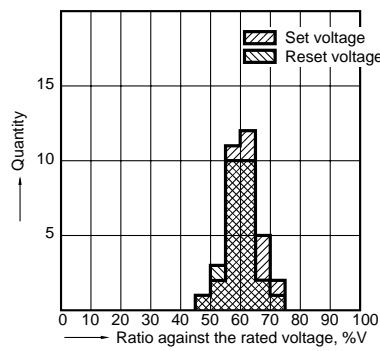

9. Ambient temperature characteristics

Tested sample: TXD2-5V, 5 pcs.

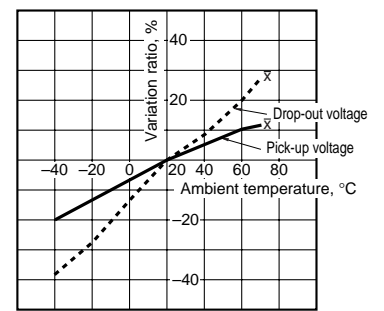

10. Distribution of contact resistance

Tested sample: TXD2-5V, 30 pcs. (30 x 4 contacts)

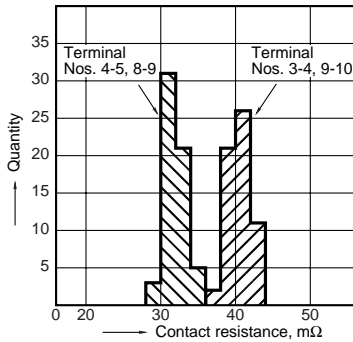

11-(1). High-frequency characteristics

Isolation characteristics

Tested sample: TXD2-12V, 2 pcs.

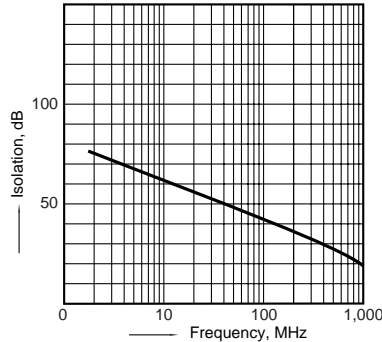

11-(2). High-frequency characteristics

Insertion loss characteristics

Tested sample: TXD2-12V, 2 pcs.

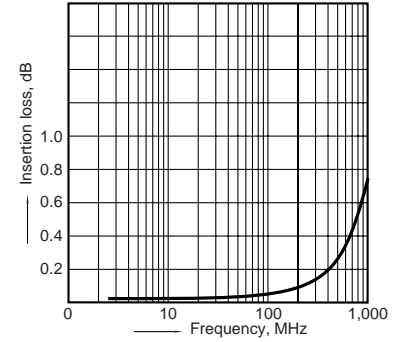

12-(1). Malfunctional shock (single side stable)

Tested sample: TXD2-5V, 6 pcs

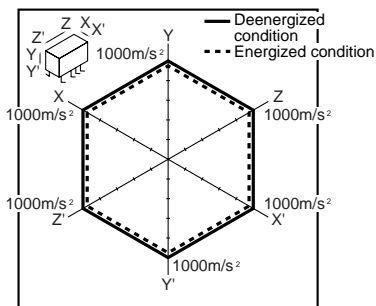

12-(2). Malfunctional shock (latching)

Tested sample: TXD2-L-12V, 6 pcs.

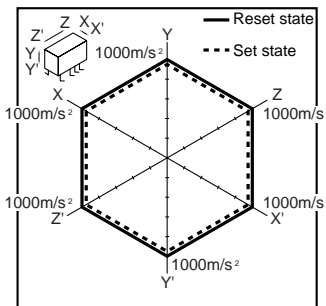

TX-D

13-(1). Influence of adjacent mounting
Tested sample: TXD2-12V, 6 pcs.

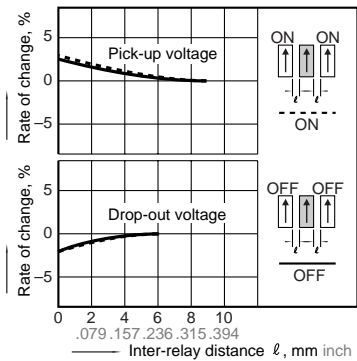

13-(2). Influence of adjacent mounting
Tested sample: TXD2-12V, 6 pcs.

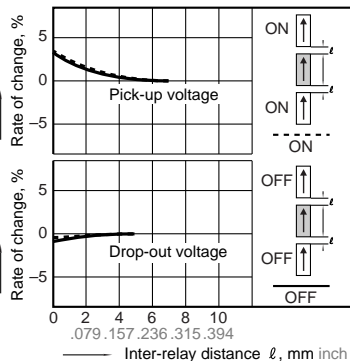

13-(3). Influence of adjacent mounting
Tested sample: TXD2-12V, 6 pcs.

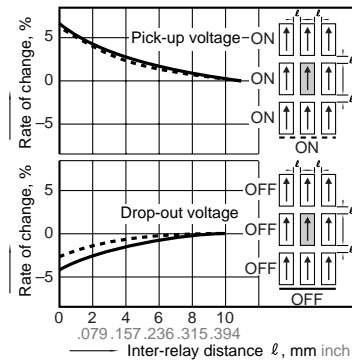

14. Actual load test (35 mA 48 V DC wire spring relay load)

Tested sample: TXD2-5V, 6 pcs.

Circuit

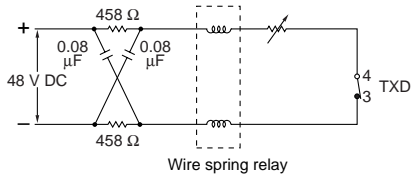

Change of pick-up and drop-out voltage

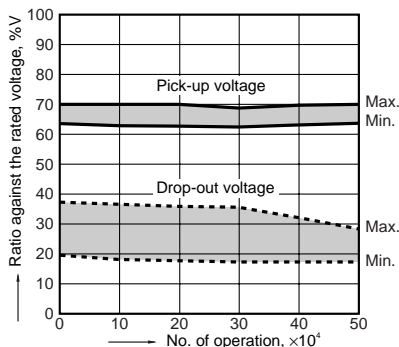

Change of contact resistance

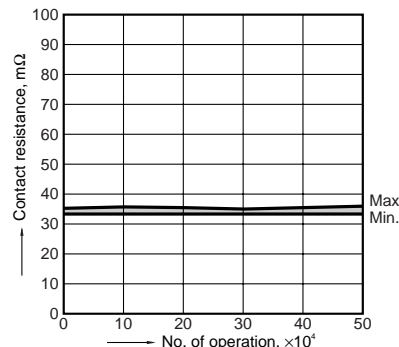

15-(1). Distribution of M.B.B. time

Tested sample: TXD2-2M-5V, 50 pcs.

Terminal No. 3-4-5: ON

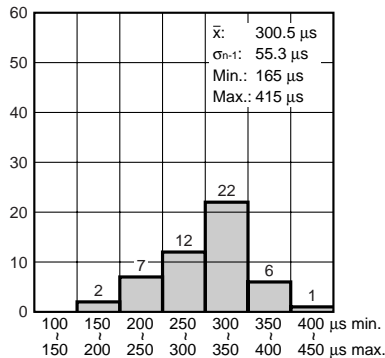

Terminal No. 3-4-5: OFF

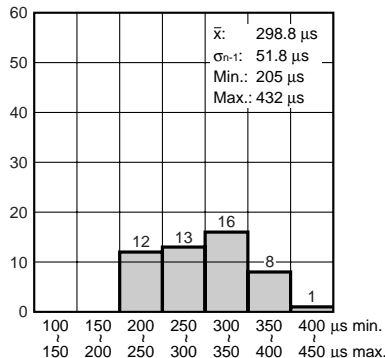

15-(2). Distribution of M.B.B. time

Tested sample: TXD2-2M-5V, 50 pcs.

Terminal No. 8-9-10: ON

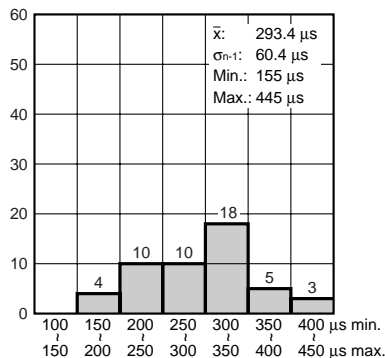

Terminal No. 8-9-10: OFF

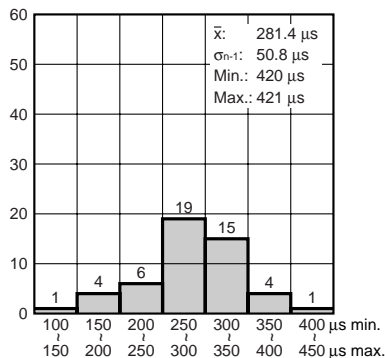

For Cautions for Use, see Page 178 and 179.